

REVISIONS	BY

HARRY D. YATES  
IRRIGATION DESIGN & PLANNING  
18298 S SPRINGWATER ROAD  
ESTACADA, OR 97023-9649  
(503) 539-2376

## IRRIGATION SYSTEM DETAIL DRAWINGS

**GOLDENDALE**  
GOLF CLUB  
GOLDENDALE, WASHINGTON

DRAWN HD / JSY	CHECKED
DATE FEBRUARY 17, 2010	SCALE NONE
JOB NO.	SHEET
3	4
OF SHEETS	

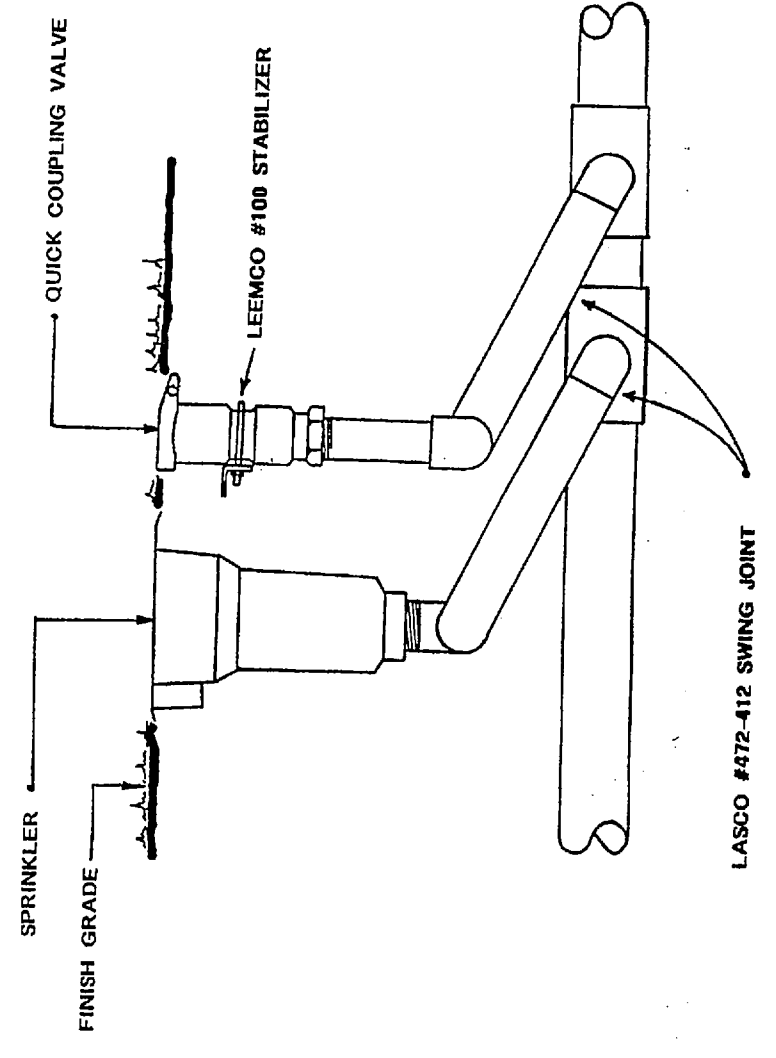

**SWING JOINT ASSEMBLY**

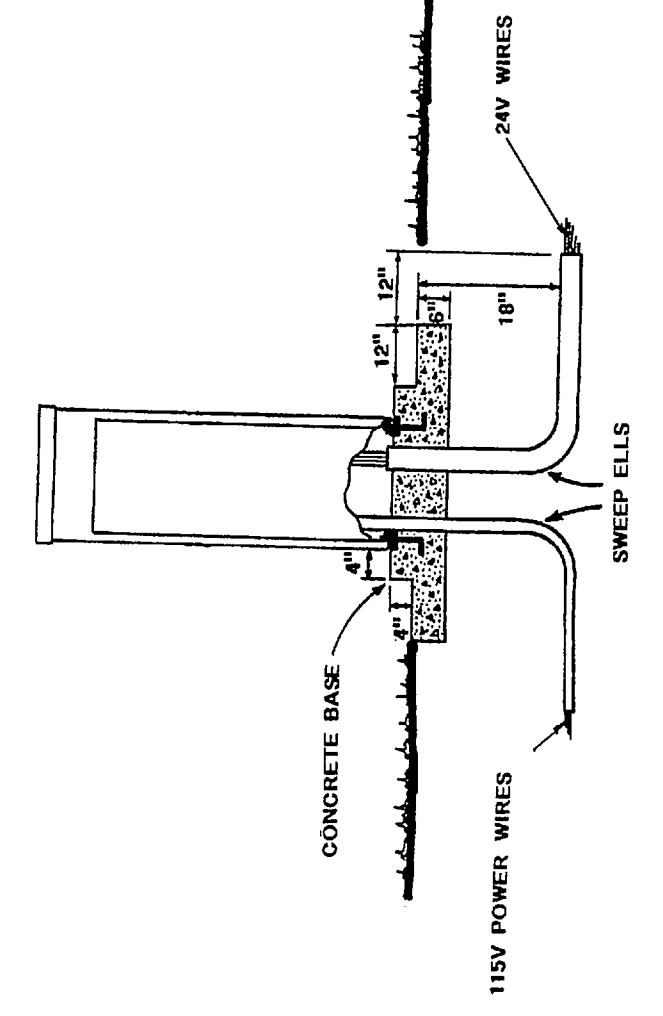

**SATELLITE ASSEMBLY**

**NOTE**

These construction details are intended to supplement the plans and any part of the work that may be mentioned in the one and not represented in the other, shall be done the same as if it had been mentioned or represented in both.

Work or materials of a minor nature which may not be specifically mentioned or represented, but which may be reasonably assumed as necessary for the construction or completion of this work, shall be performed by the contractor the same as if shown on the drawings or described in the specifications.

In general, large details will take precedence over small-scale drawings. Figures, when given, shall be followed in preference to scale measurements.

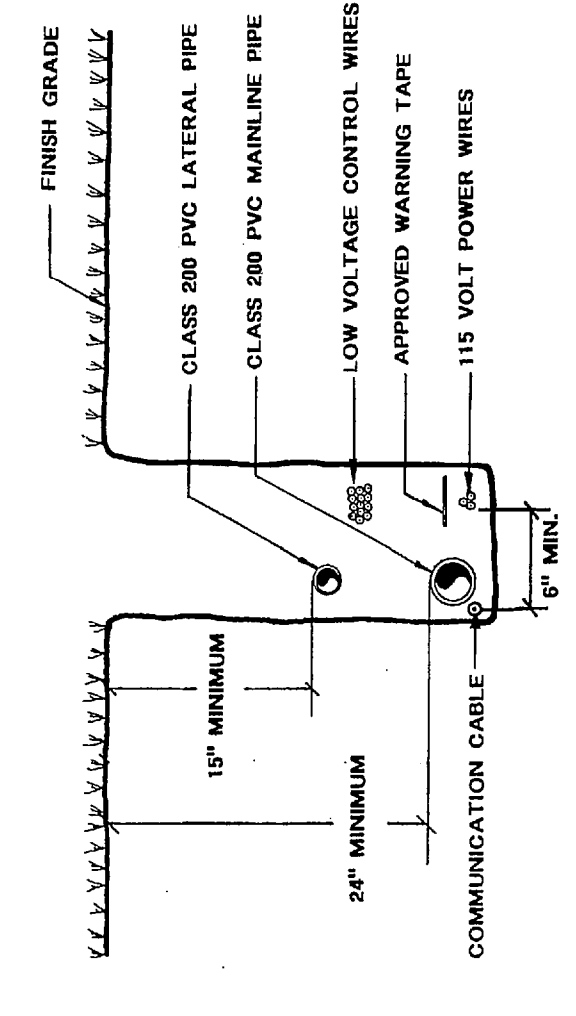

**TRENCH DETAIL**

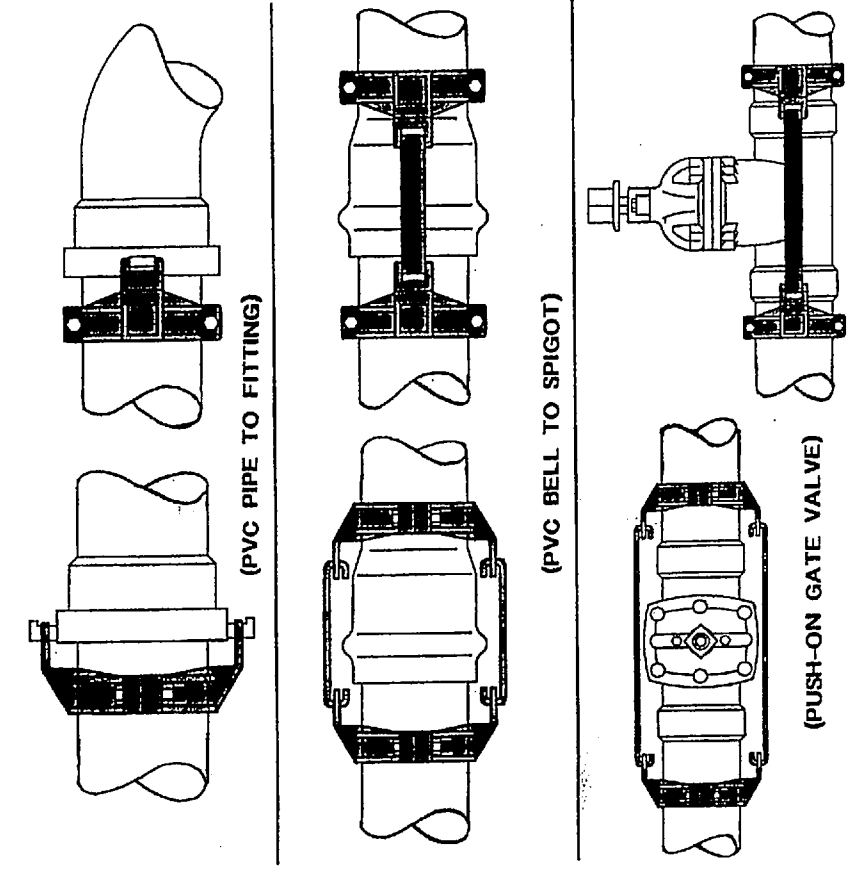

**JOINT RESTRAINT**

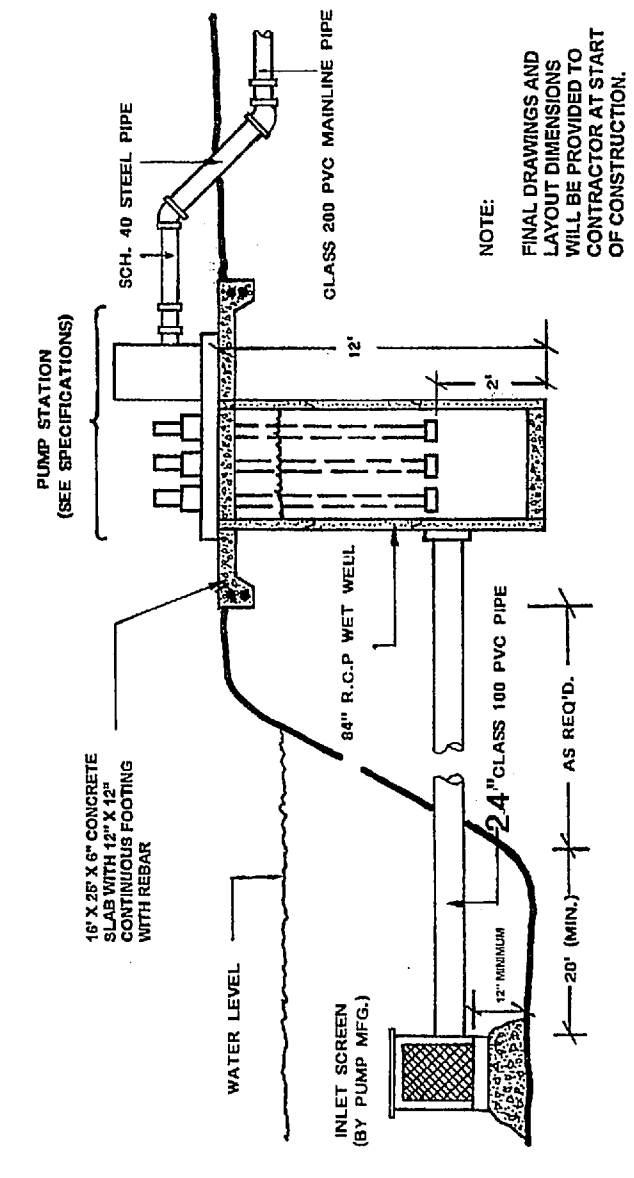

**PUMP STATION**  
NO SCALE

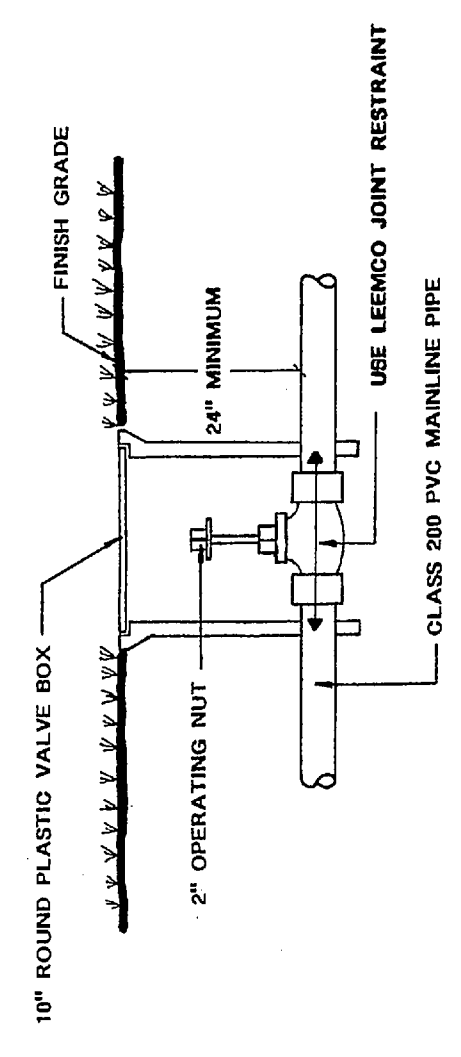

**GATE VALVE**

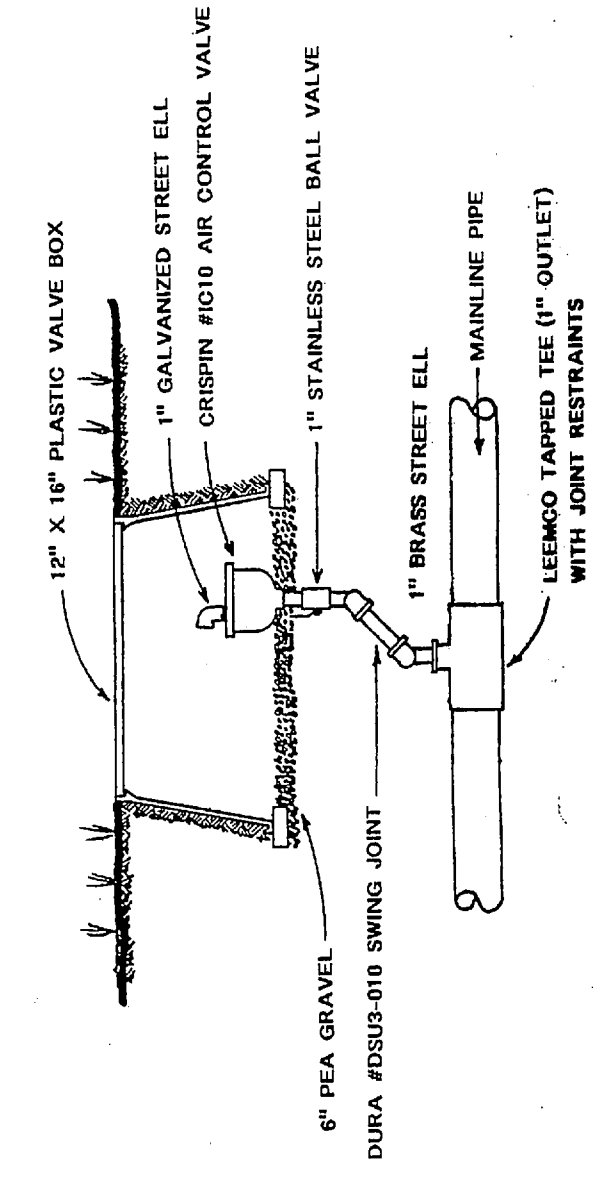

**AIR CONTROL VALVE**

NOTE: USE NYLON TAPE ON ALL MALE THREADS

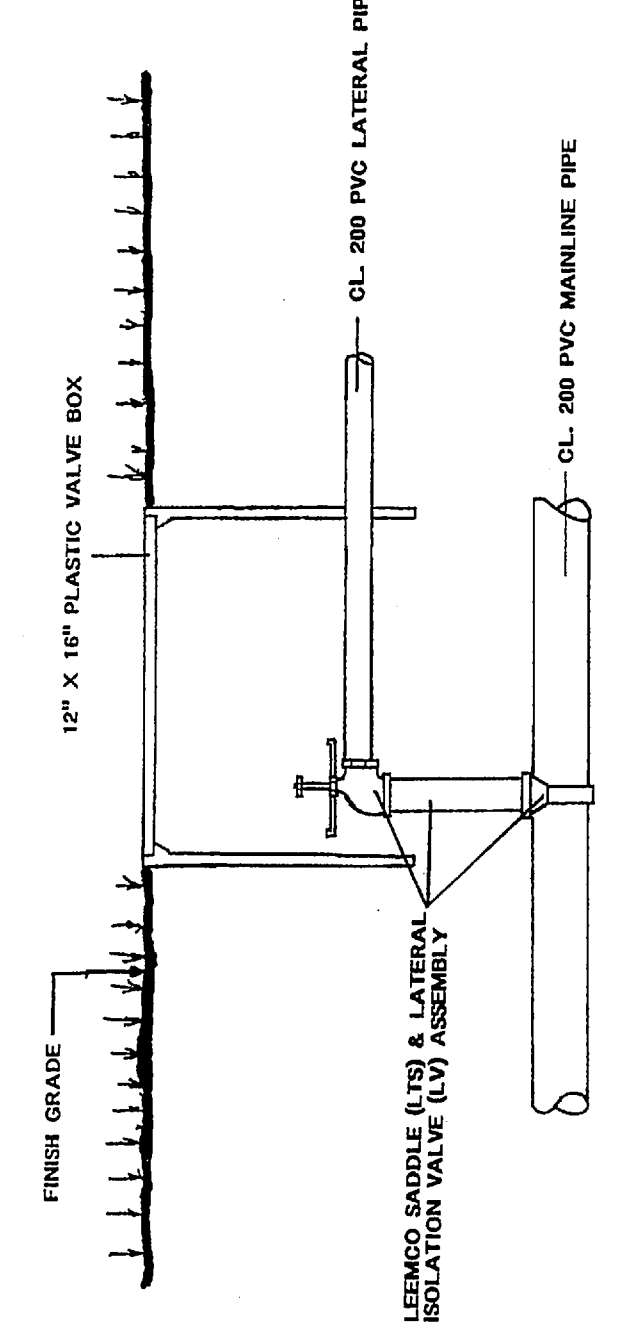

**MAIN TO LATERAL CONNECTION**